



GENUINE PARTS

INSTALLATION INSTRUCTIONS

1. **DESCRIPTION:** Hood Bug Deflector
2. **APPLICATION:** Infiniti QX80
3. **PART NUMBER:** 999D5 3W000

4. KIT CONTENTS:

Item	QTY	Description
A	1	Hood Bug Deflector
B	6	Phillips Head Screw #8-32 x 5/8"
C	6	Phillips Head Screw #10-24 x 1/2"
D	6	Nylon Washers
E	1	Left Outer Bracket (Stamped "L" on bare leg of bracket)
F	1	Right Outer Bracket (Stamped "R" on bare leg of bracket)
G	4	Inner Brackets
H	6	Protective Mylar Tape
I	6	Rubber Insert
J	1	Installation Instructions Replacement Template

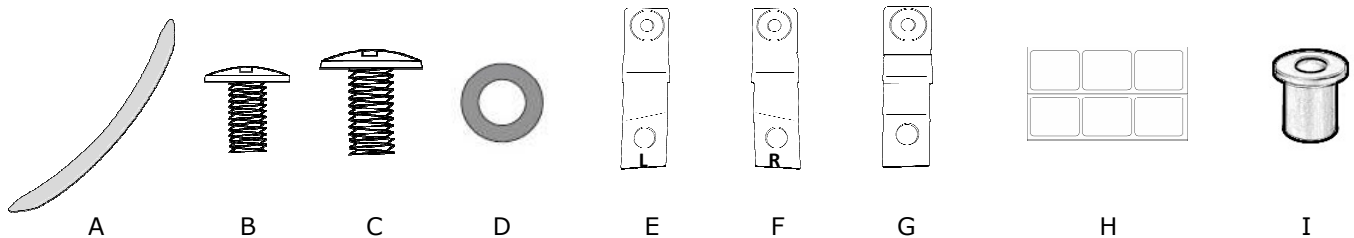

J

5. TOOLS REQUIRED:

- Car Wash Supplies
- Shop Towel
- Rust preventative coating (P/N:999MP-9G001P)
- Rubbing Alcohol
- 8mm Drill Bit
- Clip removal tool or Standard flat head screw driver.
- Tape measure or Ruler
- Masking tape
- #2 Phillips Head Screw Driver
- Hand-held Electric Drill

6. CAUTIONS/NOTES:

- To avoid damaging the surface, never use ammonia-based cleaners or solvents to clean your hood bug deflector.
- Clean hood bug deflector with a solution of mild dishwashing soap and water using a soft, lint free cloth or chamois.
- To remove fine scratches and restore the original luster, use a high quality plastic cleaner.

INSTALLATION INSTRUCTIONS - HOOD BUG DEFLECTOR

7. INSTALLATION PROCEDURE:

- 1) Open hood.
- 2) Clean hood installation area.
- 3) Clean top and underside of hood's leading edge using rubbing alcohol and shop towel.
- 4) Cover engine compartment with protective blanket to catch any dropped hardware.
- 5) Remove and discard six of the twelve weather seal push fasteners at indicated locations. Wrap protective mylar tape over the leading edge of hood at these locations.

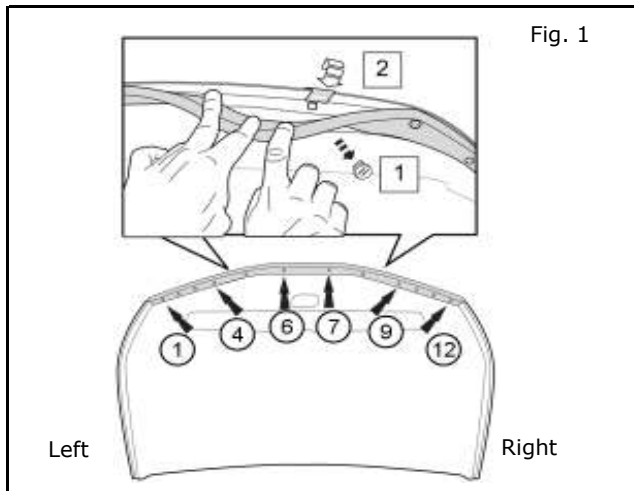

- 6) Measure 10mm from end of a 8mm drill bit and wrap with masking tape. Pull weather seal aside and drill the 6 open holes using the 8mm drill bit.

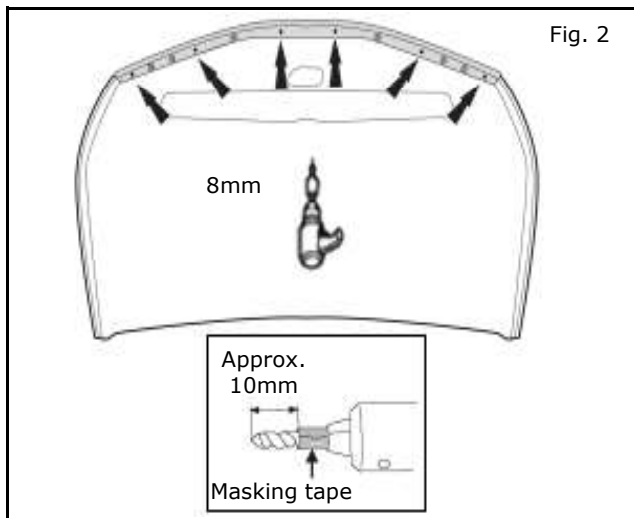

CAUTION

Apply gentle pressure while drilling to ensure that once through, the drill bit DOES NOT contact the outer surface of the hood and cause damage.

- 7) Apply rust preventative (P/N 999MP-9G001P) to drilled holes.
- 8) Install a rubber grommet in each drilled hole.
- 9) Note the brackets are marked "L" on driver side bracket and "R" on passenger side bracket just below the hole on the bracket leg and the center brackets are unmarked.

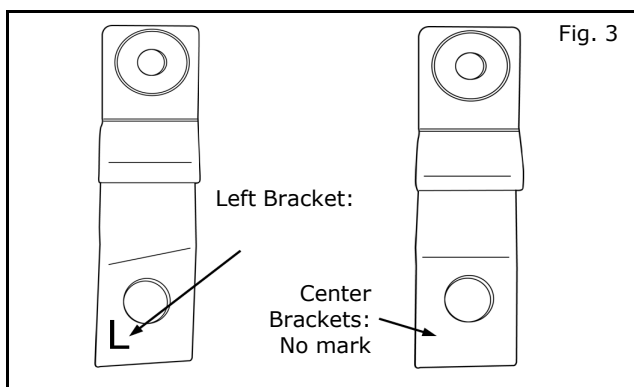

INSTALLATION INSTRUCTIONS - HOOD BUG DEFLECTOR

7. INSTALLATION PROCEDURE (CONTINUED):

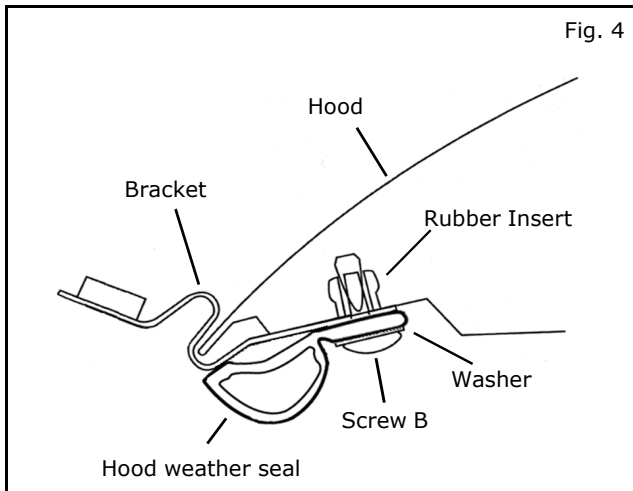

10) Slide the leg of a center bracket between the installed rubber grommet and the hood weather seal as shown.

11) Secure bracket using washer and #8-32 x 5/8" screw(B) as shown. Tighten finger tight and repeat for the other five bracket locations.

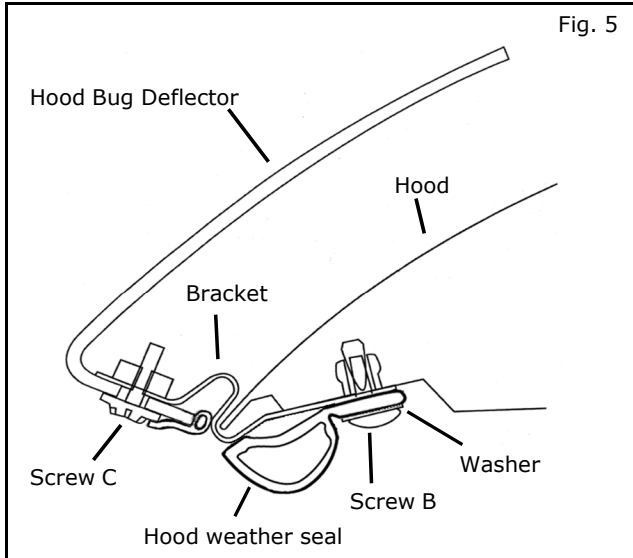

12) Secure hood bug deflector by inserting a #10-24 x 1/2", screw C as shown. Tighten finger tight and repeat for the other five bracket locations. Lift the bulb seal at screw locations and lay it over the screw heads.

13) Proceed with remaining two center brackets and finish with left and right outer brackets, tightening all fasteners to finger tight.

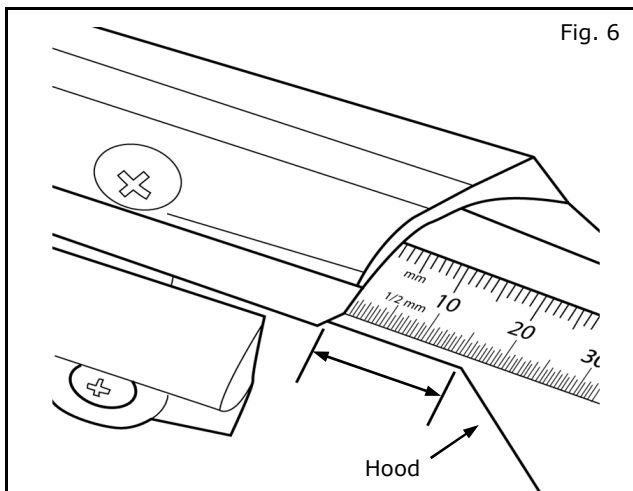

14) Measure from the corner of the hood bug deflector return flange to the corner of the hood on both left and right hand sides and adjust by pushing on the deflector to ensure the hood bug deflector is centered.

INSTALLATION INSTRUCTIONS - HOOD BUG DEFLECTOR

7. INSTALLATION PROCEDURE (CONTINUED):

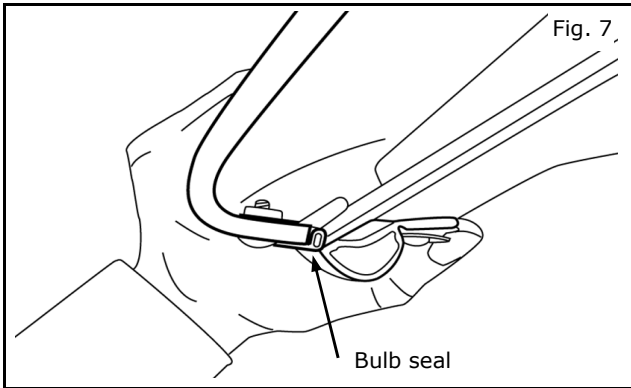

- 15) Gently push the part toward the vehicle to ensure contact and slight compression of the hood bug deflector bulb seal with the leading edge of the hood.

NOTE:

Take care that the hood bug deflector remains centered and the bulb seal is correctly positioned as shown in Fig. 7.

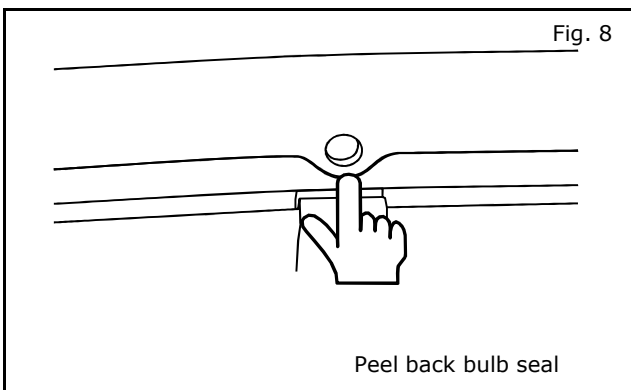

- 16) Peel back the bulb seal near the screw holes on the deflector and tighten the four screws securing the hood bug deflector to the two center brackets in the middle until snug. Do not overtighten.

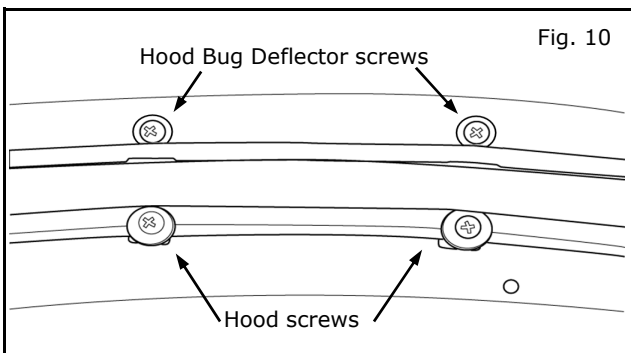

- 17) Finish tightening remaining screws, moving from left and right outer brackets working inward. Verify that hood bug deflector seal contacts the hood across the entire length of the part.

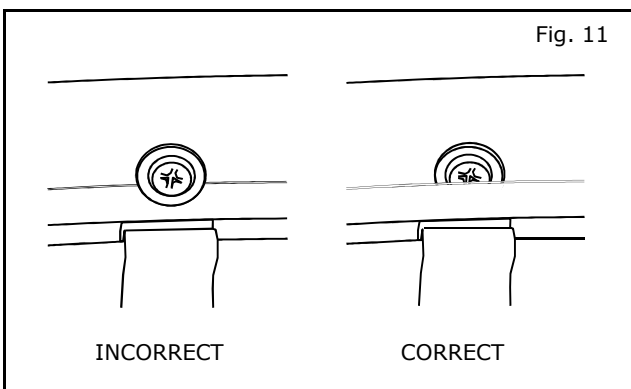

- 18) Lay the bulb seal over the screw heads as shown in Fig. 11.

INSTALLATION INSTRUCTIONS - HOOD BUG DEFLECTOR

8. CHECKLIST:

Prior to completion, verify the following:

- All screws are properly tightened and snug against a bearing surface.
- Brackets are secure and hood bug deflector does not slide fore/aft or side to side.
- Paint protection film is smooth and free of wrinkles.
- Bulb seal gasket is properly sealing to leading edge of hood.
- Hood closes and latches normally.